

CU23 Timer Module

SWISS MADE BY COMAT

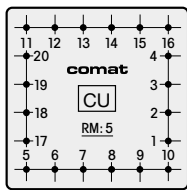

No pin on 16
32x32x15mm depth

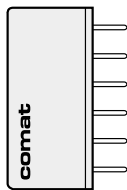

Universal Timer Module for Print Board Mounting

- large time range 6ms...8 (16) hrs
- digital CMOS time circuit with RC oscillator and subsequent frequency divider
- 5 programmable timing modes
- (+) triggering (PNP)
- separate time stop input (for use in all timing functions)

- outputs for direct relay connection through integrated suppression diodes
- 1 output (+) switching (PNP) 120 mA
- 1 output (-) switching (NPN) 150 mA (simultaneously usable)
- large voltage range DC 10...28V
- small dimensions 32x32x15mm depth
- hermetically sealed

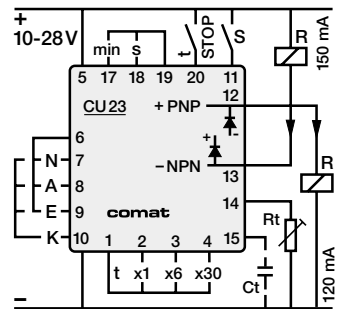
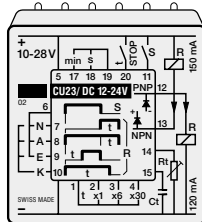

View of connections

Time ranges

Examples for external wiring

Time range		
Partial range	x1	1 2
	x6	1 3
	x30	1 4

series resistor R_v
extender capacitor C_t
adjustable resistor R_t

CU23

sec		min	
18	19	17	19
0,01-3s	0,05-30s	0,05-30m	1-300min
0,01-0,1s	0,05-1s	0,05-1min	1-10min
0,06-0,6s	0,3-6s	0,3-6min	6-60min
0,3-3s	1,5-30s	1,5-30min	30-300min

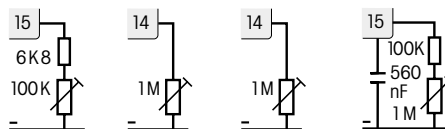

Timing functions

Programming

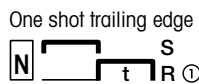
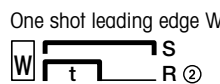
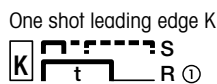
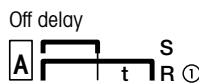

Time stop (t_{STOP}) = Time lapse interrupted

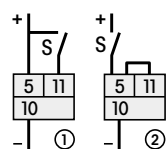

Triggering (O)

Supply

operating voltage DC 10...28V
current consumption ≤ 15 mA (without load)

Triggering (S)

minimum triggering time 1,5 ms
reset time ≤ 5 ms
S load / t_{STOP} ≤ 3 / 1,5 mA // 24V
res. to parallel load on S (11) max. 100V / 10 ms / 1Hz

Time Adjustment

time resistor R_t on 14/15 0/3k3...1(2) MΩ, ≥ 0,1W
expansion capacitor C_t 0...1 μF, ≥ 25V (foil type)

Time Accuracy

repeat accuracy ≤ 0,5% / ≤ 2 ms
voltage stability ≤ 0,05% / V, (≤ 1%)
temperature stability ≤ 0,1% / K, (≤ 1,5%)
effect of wire R_t + 1,5% / nF

Output Circuit (R)

output 1 (12) PNP transistor 120 mA
output 2 (13) NPN transistor 150 mA
leaking current ≤ 50 μA

Ambient Conditions

ambient temperature range -25° C...+60° C
storage temperature range -40° C...+85° C
climatic class DIN 40 040 HUE
vibration / impact resistance IEC 571 / >>20 g

General

case material Noryl SE1 (UL 94V-1)
protection / weight IP 64 / 20 gr.

Accessories:

external potentiometer (R_t) type SP-01/100K
type SP-01/1M
other values on request

Example of order:

1 timer module CU23/DC 12-24V

CU23

Scale approx 3/4

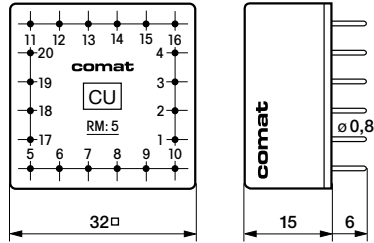

External potentiometer **SP-01/100K**
(protection IP65)

SP-01/1M
Other values
on request

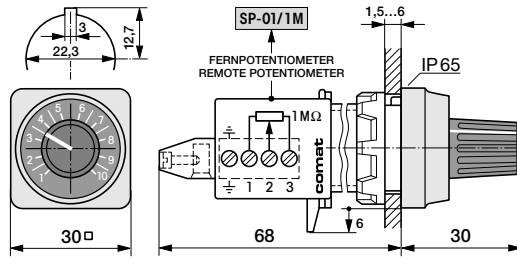

Exemple of order:

1 external potentiometer SP-01/100K



Kühn Controls S.L.
Vertriebsbüro Deutschland
Gräfenhäuser Str. 14
D-75305 Neuenbürg
Tel.: +49- (0)7082-940000
Fax: +49- (0)7082-940001
eMail: sales@kuehn-controls.de
www.multicomat.net